



Professional Blood Pressure Monitor HBP-1300

- Instruction Manual
- Mode d'emploi
- Gebrauchsanweisung
- Manuale di istruzioni
- Manual de instrucciones
- Gebruiksaanwijzing
- РУКОВОДСТВО ПО ЭКСПЛУАТАЦИИ
- Kullanım Kılavuzu

• كتيب الإرشادات

EN

FR

DE

IT

ES

NL

RU

TR

AR

Thank you for purchasing this OMRON Professional Blood Pressure Monitor.
Please completely read this Instruction Manual before using the monitor for the first time.
Read this manual to ensure the safe and accurate use of the monitor.

Contents

Introduction

Intended Use	1
Exemptions.....	1
Notes on Safety	2
Warnings and Cautions	3

Using the Unit

Components of the Product.....	10
Options	10
Features of the Product.....	11
Features / Functions of Unit	12
Installing the Battery Pack.....	14
Connecting the AC Adapter.....	15

System Settings

Menu Mode	16
Utility Mode.....	17

Non-Invasive Blood Pressure (NIBP) Measurement

Non-Invasive Pressure Measurement Principles.....	18
Cuff Selection and Connection	19
Applying the Cuff to the Patient.....	20
Taking the Measurement in “Manual Mode”	21
Taking the Measurement in “Auscultation Mode”	22
Stopping the Measurement	23
Displaying Last Reading.....	23

Maintenance

Maintenance Inspection and Safety Management	24
Cleaning of the Device	24
Accessory Care	24
Check before Use.....	25
Troubleshooting.....	26
List of Error Codes	28
Disposal.....	29

Specifications

Factory Default Settings	30
Technical Specifications: HBP-1300	30
Manufacturer’s Declaration.....	33

Introduction

Intended Use

Medical Purpose

The device is a digital monitor intended for use in measuring blood pressure and pulse rate in adult and pediatric patient population with arm circumference ranging from 12 cm to 50 cm (from 5 inches to 20 inches).

Intended User

This device should be used by a medical professional.

Patient Population

This device is intended for use on adults and children of age 3 years and older.

Environment

The instrument is designed for use in physicians' offices, hospitals, clinics and other medical facilities.

Measurement Parameter

- Non-Invasive Blood Pressure
- Pulse rate

Precautions for Use

Warnings and cautions described in the instruction manual should be observed at all times.

Exemptions

OMRON will not bear any responsibilities on the following matters.



1. When a problem or damage occurs caused by the maintenance and/or repair conducted by a person other than OMRON or the dealer specified by OMRON
2. The problem or damage of OMRON product caused by the product of other manufacturer not delivered by OMRON
3. The problem and damage caused by the maintenance and/or repair using the repair parts not specified by OMRON
4. The problem and damage caused by the results not observing the Notes on Safety or the operational method mentioned in this Instruction Manual
5. Under the circumstances not within the operating conditions of this unit including the power source or the setting environment mentioned in this Instruction Manual
6. The problem and damage caused by the result(s) of remodeling or improper repair of this product
7. The problem and damage caused by act of god such as fire, earthquake, flood, or lightning

1. The contents of this Instruction Manual may be changed without prior notice.
2. We have thoroughly reviewed the contents of this Instruction Manual. However, if an inadequate description or error is found, please let us know.
3. It is prohibited to copy a part of or the entire Instruction Manual without getting OMRON's permission. Unless this Instruction Manual is used by an individual (company), it cannot be used without getting OMRON's permission from the standpoint of the Copyright Law.

Notes on Safety

The warning signs and symbol examples indicated below are intended to ensure safe use of the product and prevent damage and injury to you and others. The signs and symbols are explained below.

Safety Symbols used in this Instruction Manual

 Warning	Indicates the matters in which death or severe bodily damage may arise as a result of incorrect handling.
 Caution	Indicates the matters in which bodily harm or material damage may arise as a result of incorrect handling.

General Information

Note: Indicates general information to keep in mind when using the unit and other useful information.

Warnings and Cautions

Usage warnings and cautions

Setup

Warning

Do not use the cuff or AC adapter to lift the unit, it can also cause the unit to malfunction.

If the unit has broken down, contact OMRON HEALTHCARE.

Do not use in combination with a hyperbaric oxygen therapy device, or in an environment where combustible gas may be generated.

Do not use in combination with magnetic resonance imaging (MRI) equipment. If MRI is to be performed, remove cuff connected to the unit from the patient.

Do not use with a defibrillator.

Do not install the unit in the following locations:

- Locations subject to vibration such as ambulances and emergency helicopters.
 - A location where there is gas or flame.
 - A location where there is water or steam.
 - A location where chemicals are stored.
-

Do not use at extremely high temperature, high humidity, or high altitude. Use only within the required ambient conditions.

Do not subject the unit to intense shock.

Do not place heavy objects on the AC adapter cable, or allow the unit to sit on the cord.

Clinical testing has not been conducted on newborn infants and pregnant women. Do not use on newborn infants and pregnant women.

Do not plug in or unplug the AC adapter with wet hands.

Caution

Do not install the unit in the following locations:

- Locations with dust, salt, or sulfur.
 - Locations directly exposed to sunlight for extended periods of time (in particular, do not leave in direct sunlight or near a source of ultraviolet light for extended periods, as ultraviolet light will cause deterioration of the LCD).
 - Locations subject to vibration or shock.
 - Near heaters.
-

Do not use the unit near large equipment that uses a switching relay for power ON/OFF.

Before use / during use

Warning

The unit complies with the EMC standard (IEC60601-1-2). As such, it can be used simultaneously with multiple medical instruments. However, if instruments that generate noise such as an electric scalpel or a microwave therapy device are near the unit, check the operation of the unit during and after use of these instruments.

If an error occurs or a measurement result is questionable, check the vital signs of the patient by auscultation or palpation. Avoid relying solely on the measurement results of the unit when judging the patient's condition.

Only trained healthcare providers should use this device. Do not allow patients to operate this device.

Properly connect the connectors and AC adapter cable.

Do not place objects or liquids on top of this unit.

Check the following before using the unit:

- Make sure the AC adapter cable is not damaged (wires are not exposed or broken), and the connections are firm.
-

For the AC adapter connected to the unit, supplies, and optional devices, use only the standard accessories or OMRON-specified products.

Do not use in a location with moisture, or a location where water may splash on the unit. This unit is intended for use in physicians' office, hospitals, clinics and other medical facilities.

Do not use the unit if it emits smoke, an abnormal odor, or abnormal noise.

Do not bring cellular telephones or transceivers into the room where the unit is installed or being used.

Do not connect multiple monitors to the same patient.

Do not connect the unit to a power outlet that is controlled by a wall switch.

Caution

Before using the unit, verify that none of the following apply to the patient:

- Poor peripheral circulation, noticeably low blood pressure, or low body temperature (there will be low blood flow to the measurement position)
- The patient uses an artificial heart and lung (there will be no pulse)
- An SpO₂ sensor and the cuff are attached to the same arm
- The patient has an aneurysm
- The patient has frequent arrhythmia
- Body motions such as convulsions, arterial pulsations, or trembling (cardiac massage in progress, minute continuous vibrations, rheumatism, etc.)

Before use, visually inspect the unit to make sure there are no deformations due to falling, and that there is no dirt or moisture on the unit.

When the unit has not been used for an extended period of time, always verify that it operates normally and safely before use.

Do not use in a location where the unit may easily fall. In the event that the unit falls, verify that it operates normally and safely.

Cleaning

Warning

When cleaning the unit, turn off the power and disconnect the AC adapter from the unit.

After cleaning the unit, make sure it is completely dry before connecting to a power outlet.

Do not spray, pour, or spill liquids into or onto the unit, accessories, connectors, buttons, or openings in the housing.

Caution

Do not use thinner, benzene, or other solvents to clean the unit.

Do not sterilize by autoclave or gas sterilization (EOG, formaldehyde gas, high-concentration ozone, etc.).

If using an antiseptic solution for cleaning, follow the instructions of the manufacturer.

Clean the unit regularly.

Maintenance and inspection

Warning

To use the unit safely and correctly, always inspect the unit when starting work.

Unauthorized modification is prohibited by law. Do not attempt to disassemble or modify the unit.

Warnings and cautions for safe measurement

Rechargeable battery

Warning

If battery fluid comes in contact with the eye, immediately flush with copious amounts of water. Do not rub. Seek medical attention immediately.

Do not use the battery pack in any other device besides this unit. Do not throw into flame, disassemble, or heat.

Always disconnect the AC adapter from the unit before removing or installing a battery.

If the unit will not be used for a month or longer, remove the battery from the unit and store. Charge the battery once every 6 months. (Storage conditions for the battery are a temperature of -20 to 30°C (-4 to 86°F) and a humidity of 65 ±20%.)

Before use, always charge the battery.

Do not attempt to disassemble or modify the battery.

Do not apply pressure to and deform the battery. Do not throw, pound, drop, bend, or hit the battery.

The battery has positive/negative polarity. If the battery does not connect well to the unit, do not forcibly connect it.

Do not connect the positive and negative terminals of the battery with a wire or other metal object. Do not carry or store a battery with metal necklaces, hairpins, or other metal objects.

Use only the specified type of battery.

Caution

Do not touch the positive and negative terminals of the battery pack with a wire or other metal object. If battery fluid comes into contact with the skin or clothes, immediately rinse with water.

Non-Invasive Blood Pressure (NIBP) measurement

Warning

If a cuff is used on a patient with an infection, treat the cuff as medical waste, or disinfect before reuse.

If frequently performing NIBP measurement using a cuff over an extended period of time, periodically check the patient's circulation. In addition, wrap the cuff as indicated in the cautionary points in this manual.

Do not connect the NIBP cuff or cuff joint to a luer lock adapter.

Do not bend cuff tube during inflation and deflation, particularly after a change of body position.

Do not wrap the cuff on the following parts:

- An upper arm on which intravenous drip or a blood transfusion is being performed.
 - An upper arm on which an SpO₂ sensor, IBP catheter, or other instrument is attached.
 - An upper arm with a shunt for hemodialysis
-

If measuring blood pressure with the cuff wrapped on the arm on the side of the body where a mastectomy was performed, check the patient's condition.

Caution

NIBP measurement should be performed on the upper arm.

During NIBP, stop excessive body movement by the patient and minimize trembling.

If a doctor has indicated that the patient has hemorrhagic diathesis or hypercoagulability, check the condition of the arm after measurement.

Use the appropriate cuff size to ensure correct measurements. If too large a cuff is used, the measured blood pressure value tends to be lower than the actual blood pressure. If too small a cuff is used, the measured blood pressure value tends to be higher.

Before and during measurement, verify that none of the following apply to the patient:

- The part where the cuff is wrapped is at a different height than the heart.
(A difference of 10 cm (4 inches) in height may cause a variation in the blood pressure value of up to 7 or 8 mmHg.)
 - Body movement or conversing during measurement.
 - Cuff wrapped over thick clothing.
 - Pressure on the arm due to a rolled up sleeve.
-

In the case of a cuff for adults, the cuff should be wrapped to a tightness that allows two fingers to be inserted in between the cuff and the arm.

The accuracy of a flashing measurement value that is out of the measurement range cannot be guaranteed. Always check the patient's condition before deciding what steps to take.

Do not use the cuff if it is damaged or has holes.

Only OMRON GS CUFF can be used with this device.

Note:

Setup

- Read and understand the manual for each optional accessory. This manual does not contain cautionary information for optional accessory.
- Exercise caution with the cables and arrange so that the patient does not become entangled or bound.

Before use / during use

- Check the following after turning on the power:
 - No smoke, abnormal odor, or abnormal noise is emitted.
 - Press each button and verify that it operates.
 - For functions that cause icons to light or flash, verify that the icons light or flash (page 13).
 - Measurement can be performed normally, and measurement error is within the tolerance value.
- If the screen is not displayed normally, do not use the unit.
- When recycling or disposing of parts (including batteries) of the unit, follow local government rules and regulations.

Cleaning

- For cleaning, see page 24.

Rechargeable battery

- To prevent accidents, keep batteries out of reach of infants and small children.
- If you sense that something is wrong with a battery, immediately move it to a safe location and contact the administrator responsible for the unit or OMRON HEALTHCARE.
- If the battery voltage is low, operation by battery may not be possible.

Non-Invasive Blood Pressure (NIBP) measurement

- If the patient has acute inflammation, a pyogenic ailment, or an external wound at the location where the cuff is to be wrapped, follow the instructions of the doctor.
- Non-Invasive Blood Pressure measurement (NIBP) is performed by compressing the upper arm. Some people may experience intense pain, or transient spotting caused by subcutaneous hemorrhaging (bruising) may appear. The spotting will disappear with time; however, it may be appropriate to inform patients for whom this may be a concern that spotting sometimes occurs, and if necessary, refrain from measurement.
- To measure correctly, it is recommended that the patient relax and not talk during measurement.
- To measure correctly, it is recommended that the patient rest quietly for 5 minutes before measurement.

Using the Unit

Components of the Product

Before using the unit, make sure that no accessories are missing and that the unit and accessories are not damaged. If an accessory is missing or there is damage, please contact OMRON HEALTHCARE.

Main unit



Standard Medical Accessories

- GS CUFF L (32 - 42 cm)/M (22 - 32 cm)
- AC adapter

Others

- Battery pack
- Instruction Manual (this paper)

Options

Optional Accessory

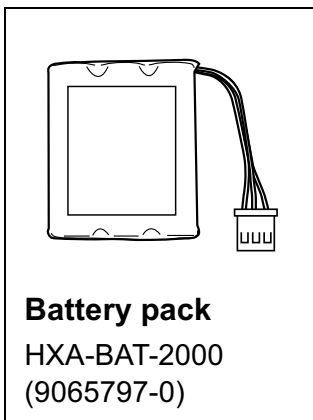

Optional Medical Accessories

(within the scope of EC Medical Device Directive 93/42/EEC)

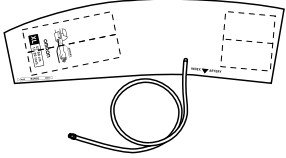
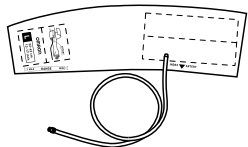
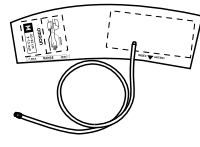
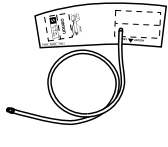
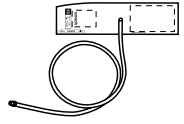
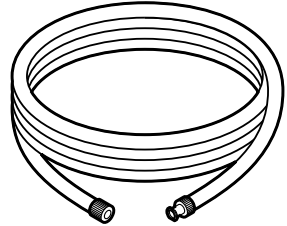
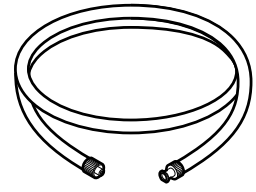
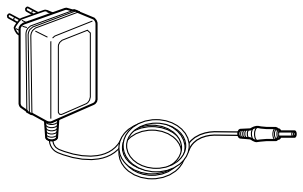
 <p>GS CUFF XL HXA-GCUFF-XLLB (9065802-0)</p>	 <p>GS CUFF L HXA-GCUFF-LLB (9065798-9)</p>	 <p>GS CUFF M HXA-GCUFF-MLB (9065799-7)</p>	 <p>GS CUFF S HXA-GCUFF-SLB (9065800-4)</p>
 <p>GS CUFF SS HXA-GCUFF-SSLB (9065801-2)</p>	 <p>CUFF HOSE No.1 (3.5m) HBP-CUFFH-BLU35 (9968171-8)</p>	 <p>CUFF HOSE No.2 (1.5m) HBP-CUFFF-BLU15 (9968172-6)</p>	 <p>AC adapter* AC ADAPTER-E1600 (9063658-2)</p>

* UK plug type
AC ADAPTER-UK1600
(9994843-9)

Caution

Only OMRON GS CUFF can be used with this device.

EN

Features of the Product

The OMRON HBP-1300 is an affordable professional blood pressure unit that is clinically proven accurate and provides fast, reliable results and is easy to use.



Key features, benefits, look

- 5 cuffs available - (SS: 12 to 18 cm, S: 17 to 22 cm, M: 22 to 32 cm, L: 32 to 42 cm, XL: 42 to 50 cm) (12 to 50 cm arm circumference range)
- Designed to be used on a table
- Motion stop function (When body movement is detected, the device stops deflation for 5 seconds.)
- Irregular pulse Indicator - Helps identify changes in heart rate, rhythm, or pulse which may be caused by heart disease or other serious health issues.
- Inflation Pressure Setting - 4 options: Auto, 220 mmHg, 250 mmHg, 280 mmHg
- Last reading display function
- Auto-Off
- Custom Rechargeable battery
- Large, easy-to-read backlight display

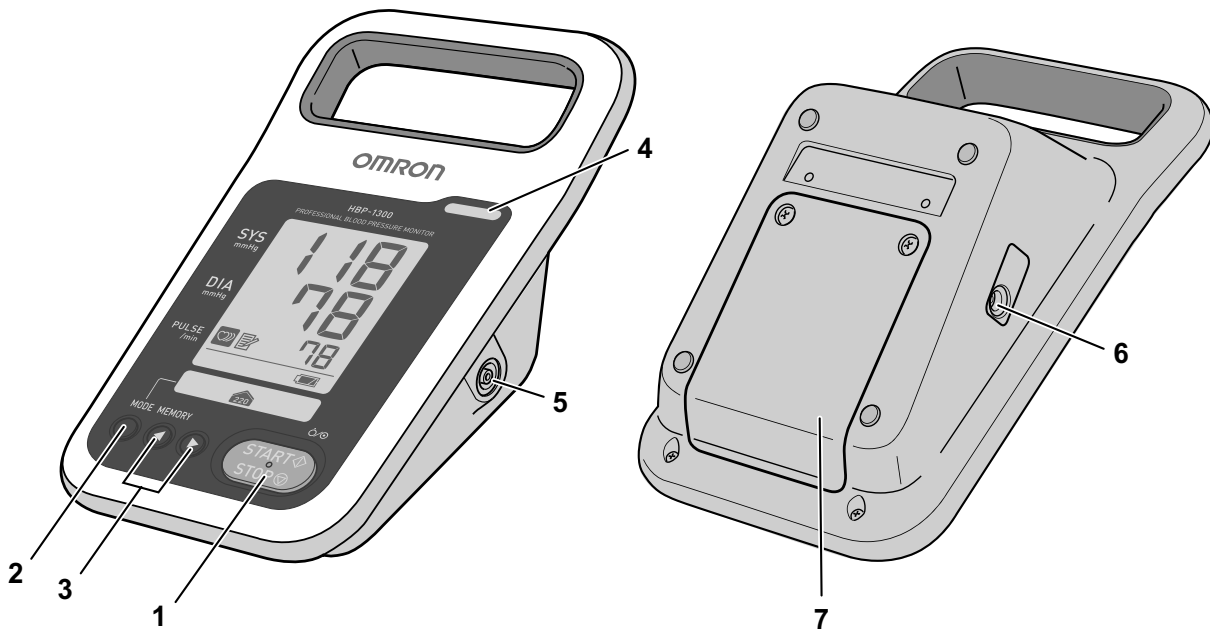

Features / Functions of Unit

Front and back of unit

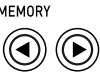







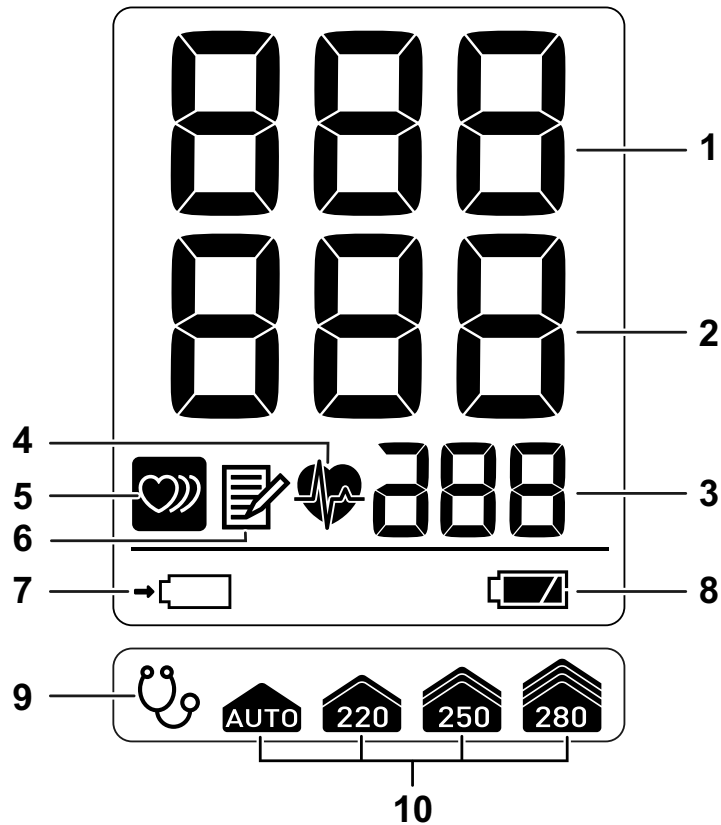

1		[START/STOP] button (Power ON/OFF)	Power ON / Measure blood pressure Press when the power is off to turn on the power and start blood pressure measurement. During inflation or measurement, press to stop.
2		[MODE] button	Power OFF Hold down at least 3 seconds to turn off the power.
3		[◀] [▶] button	Press to enter "Menu Mode" and configure various settings. If held down at least 3 seconds when a measurement result is displayed, the measured data is cleared without being stored in memory.
4		Alarm lamp	Displays the system settings (page 16) and the last reading (page 23). When using "Auscultation Mode", inflates and deflates the cuff.
5		NIBP connector	Lights up or flashes when an alarm occurs (page 28).
6		DC jack	Connects the cuff tube.
7		Battery cover	Connects the AC adapter.
			Open to install or replace the battery.

Meaning of the Symbols

Symbol	Description	Symbol	Description
	This shows the Type BF applied part.		Consult the instruction manual.
	Class II (AC Adapter)		

LCD Display



1	SYS	Displays systolic blood pressure.
2	DIA	Displays diastolic blood pressure.
3	Pulse	Displays the pulse rate.
4	 Pulse synchronization icon	Flashes in synchronization with the pulse during measurement.
5	 Irregular pulse wave icon	Lights in the measurement result display and memory display if the pulse wave interval was irregular or there was body movement during measurement (page 23).
6	 Memory icon	Lights while the previous data are being displayed (page 23).
7	 Charge icon*	Flashes during charging. Solid colored light displays when charging is finished.
8	 Battery charge level icon*	Displays how much charge the battery has (page 14).
9	 Auscultation icon	Lights when “Auscultation Mode” is ON (page 16).
10	 Inflation setting icon	The set initial Inflation pressure value lights (page 16).

* Only when the battery is installed.

Installing the Battery Pack

Warning

- If battery fluid comes in contact with the eye, immediately flush with copious amounts of water. Do not rub. Seek medical attention immediately.
- Do not use the battery pack in any other device besides this unit. Do not throw into flame, disassemble, or heat.

Caution

Do not short the positive and negative terminals of the battery pack with a wire or other metal object. If battery fluid comes into contact with the skin or clothes, immediately rinse with water.

1. **Make sure the AC adapter has been disconnected.**
2. **Remove the two screws from the top of the rear unit cover, and remove the battery cover.**
3. **Connect the battery pack to the connector on the monitor, and insert the battery pack into the compartment so that the triangle mark on the battery pack is aligned with the triangle mark on the monitor.**
4. **Replace the battery cover and secure with screws.**

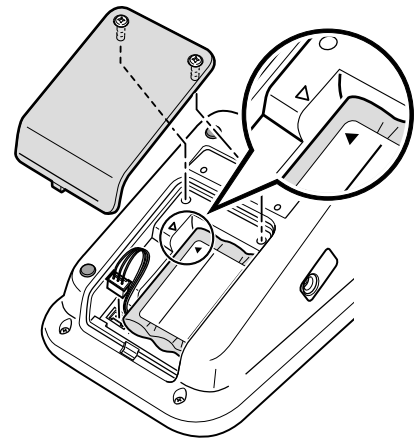

Take care not to pinch the wires when replacing the cover.

5. **Connect the AC adapter to the unit and charge the battery pack.**

When using the battery pack for the first time, be sure to fully charge (about 4 hours) before using.

Battery life

- About 300 measurements are possible with one charge.
- A general guideline for replacement of the battery pack is about one year, however, the usage time per charge may grow shorter depending on usage conditions. If you find that the usage time after each charge has grown shorter and the  icon frequently appears, replace the battery pack.

Charging time

- Charging automatically starts after the AC adapter is connected.
When a new battery pack or a battery pack that has not been used for a long time is used, some time may elapse before charging starts.
- The  icon flashes during charging.
- Charging is completed in about 4 hours.

Low battery



When the  icon starts flashing, promptly charge the battery pack.

When the icon changes to , the battery is too low for blood pressure measurement. Charge the battery.



Auto Power Off

- When the unit is powered by the battery pack, the power automatically turns off after the set time elapses if you forget to turn off the power.
- When the unit is used with the AC adapter connected, the "Auto Power Off" setting does not operate.

Battery charging

State	LCD contents and operations	Icon
Charging	The icon flashes.	
Fully charged (Charging completed)	The icon is lit.	
Problem with the battery	Error message is displayed.	-

Battery level

Battery level	LCD contents and operations	Icon
Fully charged	The icon is lit. The unit can be used.	
Battery level is 20%.	The icon flashes (E40 error not displayed). The unit can be used.	
Battery level is 5%.	The icon flashes (E40 error displayed). The unit cannot be used. If the unit is being continuously used, the power will be automatically turned off in 30 seconds.	

Connecting the AC Adapter

AC power

Verify that the power outlet supplies the specified voltage and frequency (100 - 240 V AC, 50/60 Hz).

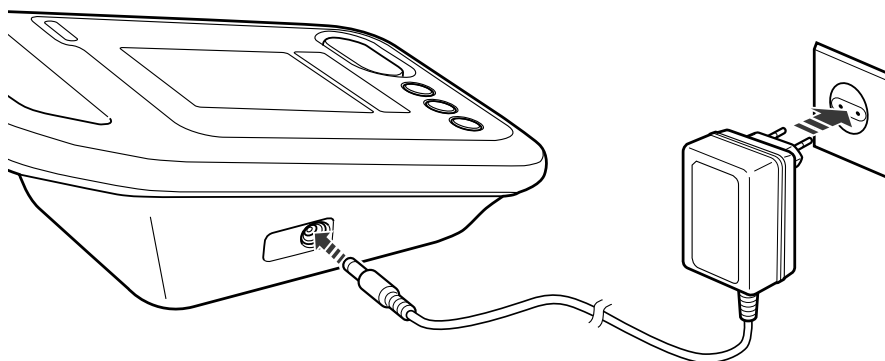

EN

Connect the AC adapter to the DC jack on the unit and the power outlet.

Note:

When the battery pack is installed

If there is no problem with the following.

- AC adapter
- DC jack
- Power outlet
- Battery

And the  icon does not flash, contact OMRON HEALTHCARE.

System Settings

The system settings are divided into two modes, “Menu Mode” and “Utility Mode”.

Menu Mode

“Menu Mode” allows you to configure the “Initial Inflation Pressure Value” and “Auscultation Mode” settings.

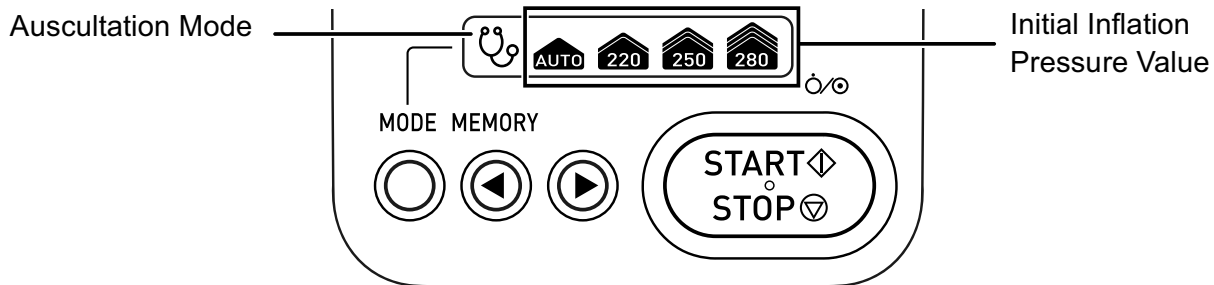

1. Press the [MODE] button.

The “Initial Inflation Pressure Value” setting screen appears.

121
P-R-S

2. Press the [◀] or [▶] button to change the setting.

- Press the [◀] button to change the setting in the order “280”, “250”, “220”, “AUTO”, “280”...
- Press the [▶] button to change the setting in the order “220”, “250”, “280”, “AUTO”, “220”...

When the “Initial Inflation Pressure Value” is set, inflation takes place at a fixed speed to the set value and thus is quicker.

“AUTO” estimates the systolic blood pressure during inflation and automatically inflates the cuff to a suitable value.

When using “220”, “250”, or “280” mmHg, select the value that is 30 to 40 mmHg higher than the estimated systolic blood pressure.

3. When you have completed the “Initial Inflation Pressure Value” setting, press the [MODE] button.

The “Auscultation Mode” settings screen appears.

AUS
OFF

— “ON” or “OFF” appears.

4. Press the [◀] or [▶] button to set to “ON” or “OFF”.

When set to “ON”, SYS and DIA can be recorded using auscultation measurement.

For information on auscultation measurement, see page 22.

5. When you have completed the “Auscultation Mode” setting, press the [MODE] button.

“0” appears.

To start blood pressure measurement, press the [START/STOP] button.

Note:

- The body movement detection function is disabled while “Auscultation Mode” is in use.
- If the power is turned off, the settings revert to the factory settings.
“Initial Inflation Pressure Value” changes to “AUTO”, and “Auscultation Mode” changes to “OFF”.

Utility Mode

“Utility Mode” allows you to configure the “Auto Power Off” and “Pressure Accuracy Confirmation” setting.

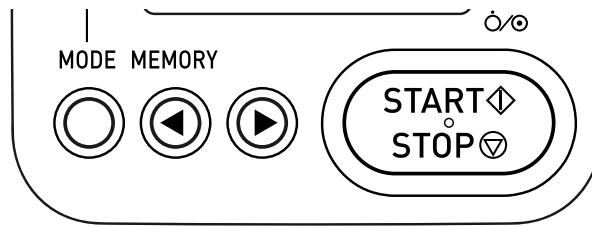

1. Confirm that the device is switched off.

If the power is on, hold down the [START/STOP] button for at least 3 seconds to turn off the power.

2. Hold down the [MODE] button until the “Auto Power Off” setting screen appears.

The “Initial Inflation Pressure Value” setting screen appears, and changes to the “Auto Power Off” setting screen appears.

3. Press the [◀] or [▶] button to change the auto power off setting.

The “5 min.” or “10 min.” setting is entered.

When the unit is powered by the battery pack and is not used for the set time (“5 min.” or “10 min.”), the power automatically turns off to save battery power.

If a mid-priority alarm other than a low battery error (E40 error) has occurred, the power does not turn off automatically.

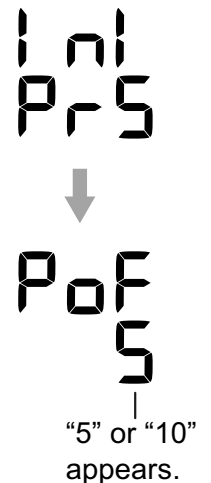

4. When you have completed the “Auto Power Off” setting, press the [MODE] button.

The “Pressure Accuracy Confirmation” screen appears. “0” appears.

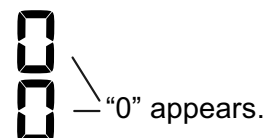

5. Check the Pressure Accuracy.

Add pressure externally as explained on page 24.

Compare with the displayed value and verify that there is no problem.

6. When you have completed “Pressure Accuracy Confirmation”, press the [START/STOP] button.

The power turns off.

EN

Non-Invasive Blood Pressure (NIBP) Measurement

Non-Invasive Pressure Measurement Principles

Oscillometric method

The beat in the pulsation generated by the contraction of the heart is captured as the pressure inside the cuff to measure the blood pressure. If the cuff wrapped around the upper arm is pressurized sufficiently, the blood flow stops, but the beat of the pulsation is present and the pressure inside the cuff receives this and oscillates. Next, as the pressure inside the cuff gradually decreases, the oscillation of the pressure within the cuff gradually increases and reaches a peak. As the pressure within the cuff decreases further, the oscillation decreases from its peak.

The pressure within the cuff and the relationship with the increase and decrease of the oscillation within the cuff in this series of processes are stored into memory, calculations are carried out, and the blood pressure value is determined.

The pressure within the cuff when the oscillation increases drastically is the systolic pressure and the pressure within the cuff when the oscillation decreases drastically is the diastolic pressure. Also, the pressure within the cuff when the oscillation peaks is taken as the average pulsation pressure.

The oscillometric method does not determine the blood pressure value instantly like a microphone type automatic blood pressure gauge with the auscultation method, but rather determines it from the series of change curves as explained above. Therefore, it is not easily affected by external noise, an electric scalpel or other electro surgical instruments.

KOROTKOV SOUNDS

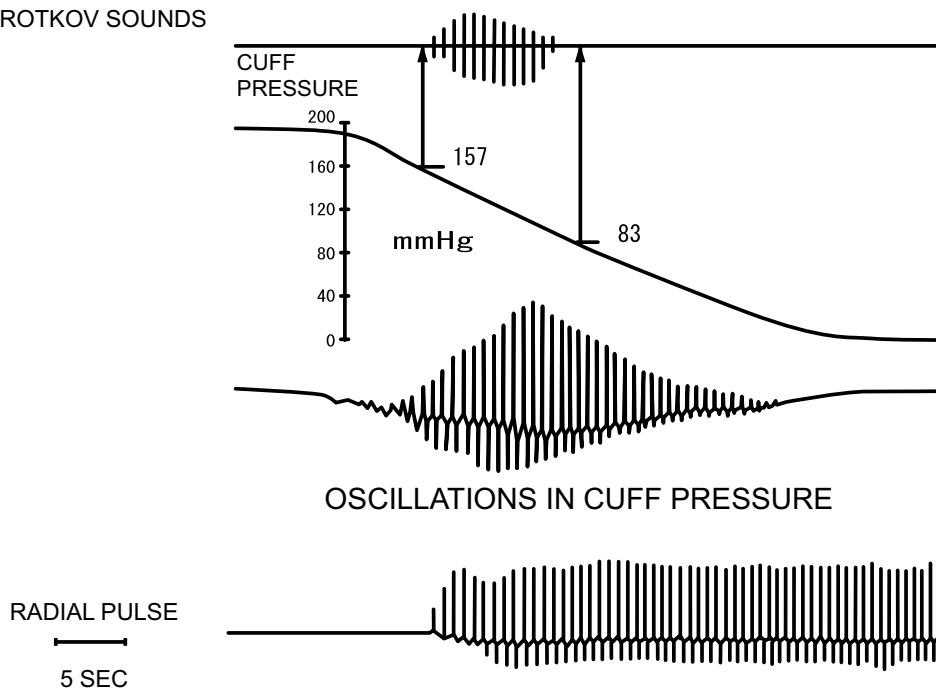

Comparison between the auscultatory, oscillometric and palpatory methods of measuring blood pressure.

L.A. Geddes,

“The Direct and Indirect Measurement of Blood Pressure”, Year Book Medical Publishers, Inc. 1970

Cuff Selection and Connection

Selecting the cuff

Warning

If a cuff is used on a patient with an infection, treat the cuff as medical waste, or disinfect before reuse.

Caution

- Do not use the cuff if it is damaged or has holes.
- Use the appropriate cuff size to ensure correct measurements. If a cuff that is too large is used, the measured blood pressure value tends to be lower than the actual blood pressure. If a cuff that is too small is used, the measured blood pressure value tends to be higher.

Note:

It is important to use the correct sized cuff for a patient in order to get an accurate reading.

Measure the circumference of the patient's arm and select the cuff size that is appropriate for the circumference.

Select the cuff that is suitable for the patient from the cuffs below.

Cuff name	Arm circumference	
	(cm)	(inch)
GS CUFF XL*	42 - 50	17-20
GS CUFF L	32 - 42	13-17
GS CUFF M	22 - 32	9-13
GS CUFF S*	17 - 22	7-9
GS CUFF SS*	12 - 18	5-7

* Available as an optional accessory.

Connecting the cuff

Connect the cuff tube to the NIBP connector on the unit and turn clockwise to lock.

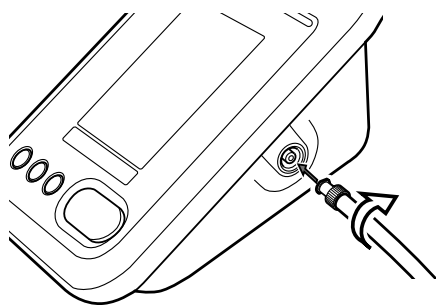

Caution

Only OMRON GS CUFF can be used with this device.

Note:

- If the cuff tube is too short, the optional 3.5 m or 1.5 m CUFF HOSE can be connected to lengthen the cuff tube. Do not extend other than the optional 3.5 m or 1.5 m CUFF HOSE, as this will affect measurement accuracy.
- Make sure the connections are tight.

Applying the Cuff to the Patient

1. Wrap on a bare arm or over thin clothing.

Wrap the cuff on a bare arm or over thin clothing. Thick clothing or a rolled up sleeve will cause inaccurate blood pressure measurements.

The device can be used on either the right or left arm.

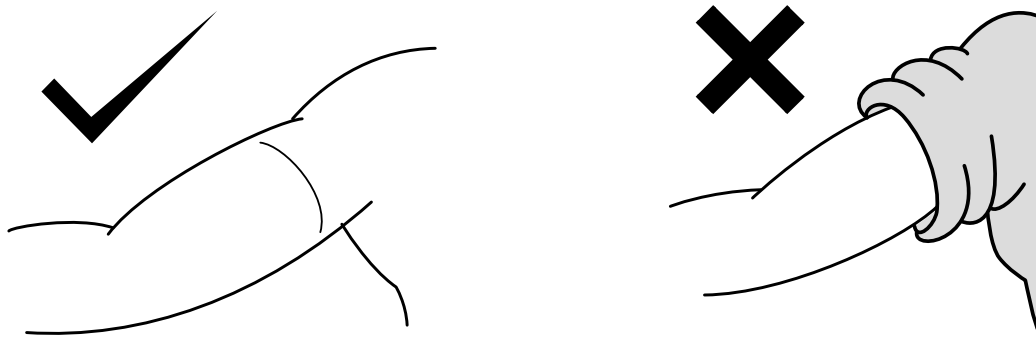

2. Align the artery mark “INDEX ▼ ARTERY” with the brachial artery.

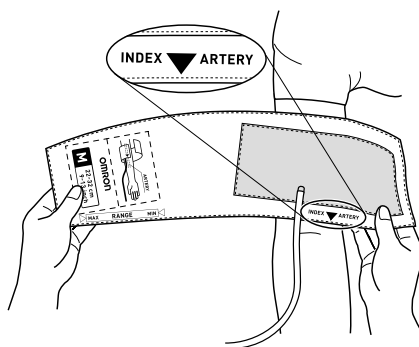

Run the cuff tube out the peripheral side with no bends (the brachial artery is on the inner side of the patient's upper arm).

Make sure that “INDEX ▼ ARTERY” is within the “RANGE” and the lower edge of the cuff is 1 to 2 cm from the inner side of the elbow joint.

If “INDEX ▼ ARTERY” is outside the “RANGE”, error in the blood pressure value will increase. In this case, use a different cuff size.

As a guideline for the tightness of the cuff, It should be possible to insert about two fingers under the cuff.

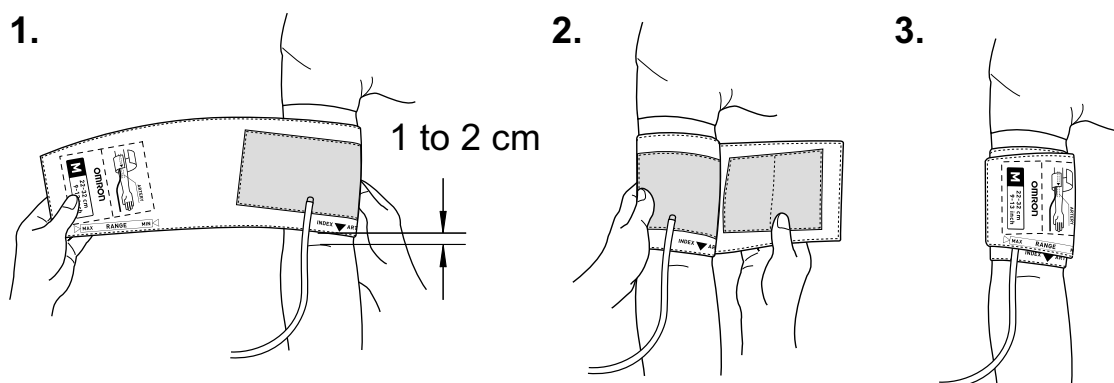

3. During measurement, keep the brachial artery on which the cuff is wrapped at the same height as the right atrium of the heart.

Caution

Make sure the cuff is wrapped in the correct arm position and is at the same height as the heart. A difference of 10 cm (4 inches) in height may cause a variation in the blood pressure value of up to 7 - 8 mmHg.

Note:

- If measurement is difficult due to arrhythmia, use a different blood pressure measurement method.
- If the patient has acute inflammation, a pyogenic ailment, or an external wound at the location where the cuff is to be wrapped, follow the instructions of the doctor.
- Non-Invasive Blood Pressure (NIBP) measurement is performed by compressing the upper arm. Some people may experience intense pain, or transient spotting caused by subcutaneous hemorrhaging may appear. The spotting will disappear over time, however, if it is possible that this will disturb the patient, try the following technique:
 - Wrap a thin towel or cloth (one layer) under the cuff.
If the towel or cloth is too thick, there will be insufficient cuff compression and the blood pressure value will measure high.
- If the patient moves or the cuff is touched, this may be falsely detected as a pulse and over-inflation will occur.
- Do not inflate the cuff when it is not wrapped on the upper arm. This may damage the cuff.

Taking the Measurement in “Manual Mode”

1. Press the [START/STOP] button.

Blood pressure measurement is performed once.

2. The measurement results are displayed.

If a measurement value is outside the corresponding range below, the value will flash.

SYS: 59 mmHg or less, or 251 mmHg or higher.

DIA: 39 mmHg or less, or 201 mmHg or higher.

PULSE: 39 bpm or less, or 201 bpm or higher.

■ Normal measurement

■ Measurement error / failure

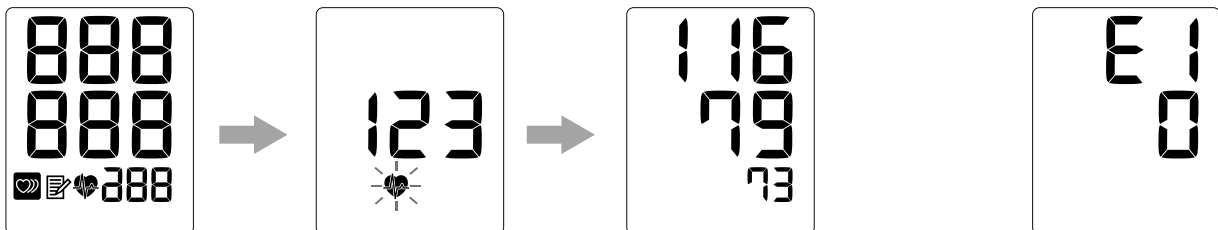

EN

Caution

The accuracy of a flashing measurement value that is outside the measurement range is not guaranteed. Always check the patient's condition before deciding what steps to take.

Note:

If inflation is insufficient, inflation may restart automatically while measurement is in progress.

Irregular pulse wave detection function

If the pulse wave interval becomes irregular during measurement, the irregular pulse wave detection icon will light to notify you.

Body movement detection function

If body movement is detected during measurement, deflation stops for 5 seconds. The irregular pulse wave icon appears in the measurement result display.

■ Deflation stopped

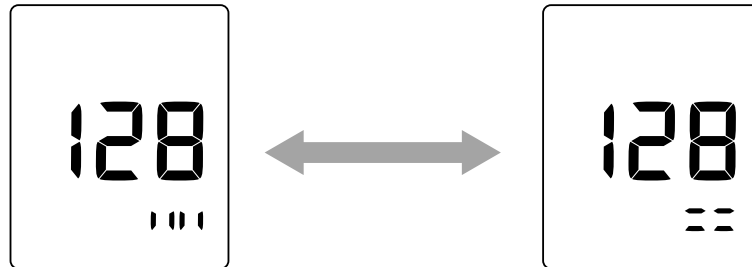

After 5 seconds, measurement resumes, and an attempt is made to complete measurement in one cycle.

Taking the Measurement in “Auscultation Mode”

Use a stethoscope to perform measurement.

When set to “ON”, SYS and DIA can be recorded using auscultation measurement.

To determine SYS and DIA during measurement, press the [MODE] button.

SYS is registered the first time and DIA is registered the second time you press the [MODE] button during deflation.

After DIA is determined, the cuff rapidly deflates and SYS and DIA are displayed as the measurement results.

The pulse rate does not appear in the measurement result display.

During deflation, the [▶] button can be held down to re-inflate, or the [◀] button can be held down to deflate faster.

Stored data that was measured in “Auscultation Mode” is displayed when the auscultation icon is lit.

■ During re-inflation

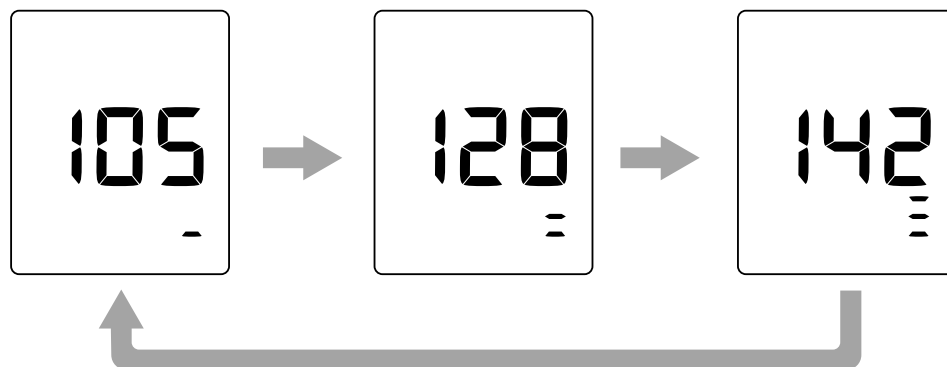

Note:

The body movement detection function is disabled while “Auscultation Mode” is in use.

For Auscultation Mode settings, see page 16.

Stopping the Measurement

To stop measurement while measurement is in progress, press [START/STOP] button.

Displaying Last Reading

The previous measurement value (systolic blood pressure, diastolic blood pressure, and pulse rate) and whether or not an irregular pulse wave was detected can be displayed. In the case of auscultation measurement, the auscultation icon appears.

Press the [◀] or [▶] button to display the previous data. This function is also available when the device is switched off.

If an irregular pulse wave or body movement was detected, the irregular pulse wave icon appears.

When the data was measured in "Auscultation Mode", the auscultation icon appears.

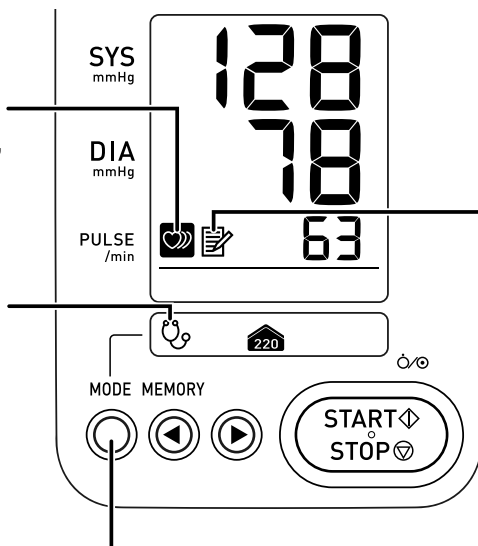

Lights while the previous data are being displayed.

If held down at least 3 seconds when a measurement result is displayed, the measured data is cleared without being stored.

Note:

When the monitor is left idle for one minute, the backlight will disappear.

Maintenance

Maintenance Inspection and Safety Management

The HBP-1300 must be maintained to ensure functionality and to secure the safety of patients and operators. Daily checks and maintenance should be performed by the operator. (page 25)

In addition, qualified personnel are necessary to maintain the performance and the safety, and to conduct periodic inspections. We recommend that the verification test be performed at least once a year.

Example of connection for pressure accuracy confirmation:

1. Display the pressure accuracy confirmation screen as explained in “Utility Mode” on page 17.

Display “0” in the pressure accuracy confirmation screen.



— Display the pressure value.

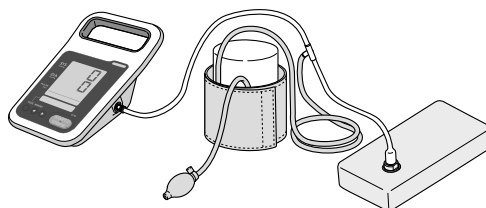

2. Connect the blood pressure monitor, the calibrated reference pressure gauge, and the cuff and inflation bulb.

3. Check the pressure value of the blood pressure monitor and the pressure value of the calibrated reference pressure gauge.

Note:

- Make sure that the blood pressure monitor reading is within ± 3 mmHg compared to the calibrated reference pressure gauge.
- To rapidly deflate the cuff, press the [] button.

To repeat “Pressure Accuracy Confirmation”, turn off the power and repeat the procedure from step 1 in “Utility Mode” on page 17.

Cleaning of the Device

Cleaning and disinfecting should be performed in accordance with your facility’s infection control practice.

Surface cleaning

Wipe with a cloth that has been moistened with isopropyl alcohol diluted to 50 v/v%, or ethyl alcohol (disinfection alcohol) diluted to 80 v/v% or less and wrung out.

Do not wipe the DC jack or allow it to become wet.

Removing dust

Use a moistened cotton bud to remove dust that has accumulated on the vent ports.

Service

The device requires no routine service other than cleaning, and visually checking the cuffs, tubing, etc.

Caution

- Do not sterilize by autoclave or gas sterilization (EOG, formaldehyde gas, high-concentration ozone, etc.).
- If using an antiseptic solution for cleaning, follow the instructions of the manufacturer.

Accessory Care

Non-Invasive Blood Pressure Measurement (NIBP)

Cuff

Wipe clean on the surface of the cuff with a cloth moistened with a 70 v/v% dilution of isopropyl alcohol, or a 80 v/v% or less dilution of disinfection ethanol (ethyl alcohol).

Do not allow any liquids inside the cuff. If a liquid gets in the cuff, dry the inside well.

Check before Use

Before conducting safety checks, be sure to implement the items in the “Cleaning of the Device” and “Accessory Care” sections. (page 24)

Before turning on the power

Before turning on the power, check for the following

External appearance

- The device or accessories are not deformed due to falling or other impact.
- The device is not dirty.
- The device is not wet.

AC adapter

- The AC adapter is firmly connected to the connector on the device.
- There are no heavy objects lying on the AC adapter cable.
- The AC adapter cable is not damaged (core-wire exposure, breaks, etc.).

When turning on the power

When turning on the power, check the following

Display/lamp

- When the [START/STOP] button is pressed to turn on the power, the screen below appears and the alarm lamp lights (page 13).

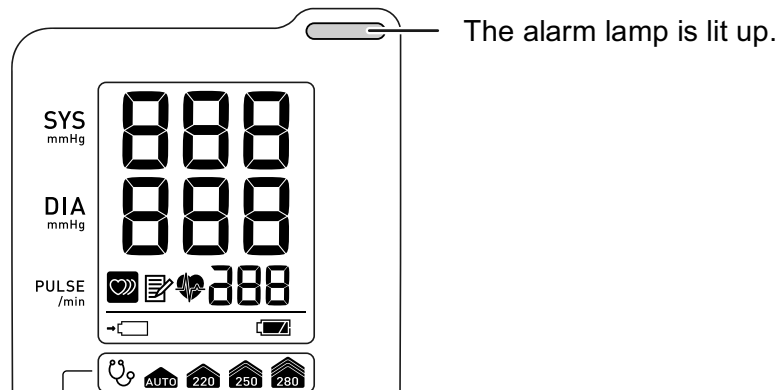

EN

After turning on the power

After turning on the power, check for the following

External appearance

- There is no smoke or odor coming from the device.
- The device is not making any unusual noises.

Buttons

- Press each button and check that it works.

Non-invasive blood pressure (NIBP)

- Make sure that a suitable OMRON GS CUFF is attached (one that fits the circumference of the patient's arm).
- The cuff tube is firmly connected.
- The person checking the cuff should wrap the cuff around arm, perform cuff measurement and check to see that blood pressure is in the vicinity of normal measurements.
- While measurement is in progress, bend the relevant arm and move body to halt discharge and during this halt check that cuff pressure does not drop.

Troubleshooting

The power does not turn on	
Cause	Solution
If the unit is being powered by the battery, the battery is not installed or the charge is depleted.	Insert battery or replace with a new battery (page 14).
Internal part failure	Disconnect the AC adapter, remove the battery, and contact OMRON HEALTHCARE.
<ul style="list-style-type: none"> • Check if the AC adapter is disconnected or the connection is loose. • Check if the AC adapter or battery has failed. 	

The unit display does not operate
Cause / solution
Stop using the unit and contact OMRON HEALTHCARE.

The unit becomes hot	
Cause	Solution
An object is on top of the unit or right next to the unit.	Keep the area around the unit free of objects.
If the unit becomes too hot to be touched, there may be a problem in the unit. Turn off the unit power, disconnect the AC adapter, remove the battery, and contact OMRON HEALTHCARE.	

The unit is connected to a power outlet, but it runs on the the battery pack	
Cause / solution	
If AC power cannot be supplied, the unit will operate by battery only.	
<ul style="list-style-type: none"> • Check if the AC adapter is properly connected to the unit. • Check if AC adapter is connected to a power outlet. • Check that the electrical outlet is working by connecting a different device to the same power outlet. 	

The cuff does not inflate when the [START/STOP] button is pressed	
Cause	Solution
Loose cuff tube connection.	Check the connection.
There is an air leak in the cuff.	Replace the cuff.
If pressure is displayed, the cuff tube is bent.	Make sure no part of the cuff tube is bent.

Measurement was not possible	
Cause / solution	
Check the patient by palpation or other method.	
After checking the patient, check the error code and see "List of Error Codes" (page 28) for Non Invasive Blood Pressure (NIBP) measurement.	

Abnormal measurement value

Cause / solution

The causes below are possible. Check the patient by palpation and then repeat measurement.

- Body movement (chills or other trembling)
- Arrhythmia.
- Noise in the cuff
 - A nearby person touched the patient.
 - Cardiac massage was being performed.

The measurement value is questionable

Cause

Solution

Deflates quickly

Check for a loose cuff connection.

Stethoscope

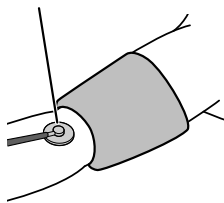

Simultaneously perform measurement with a stethoscope.
Place the stethoscope and listen while viewing the pressure display of the manometer.

Blood pressure may vary widely due to physiological effects.

The causes below are possible.

- Emotional excitement or agitation
 - Pain due to cuff wrapping
 - White coat hypertension
- Cuff size or wrapping method not correct
- Cuff wrapping position on upper arm not at the same height as the heart
- Patient's blood pressure not stable due to pulsus alternans, respiratory changes, or other reason

Incorrect cuff size used.

Measure circumference of patient's arm and ensure correct sized cuff is used.

Cuff wrapped over thick clothing.

Ensure cuff is applied to a bare arm, or very thin clothing.

Patient not seated properly.

Ensure patient is seated, feet flat on the floor, cuff at heart level.

Patient ate, drank, or exerted themselves recently.

Ensure before measurement taken, patient has not had food, caffeinated or alcohol beverages, or exerted/exercised in the last 30 minutes.

EN

List of Error Codes

The alarm lamp flashes when a medium-priority alarm occurs, and lights steadily when a low-priority alarm occurs.

To clear an alarm, press any button.

- If a low-priority alarm and a medium-priority alarm occur at the same time, the medium-priority alarm is displayed.

If the alarms are the same priority level, the error code of the alarm that occurred first is displayed.

However, to prevent battery consumption when powered by battery, a low battery error (E40 error) is always given priority.

- Example: E2

E2

SYSTEM

Error code	Priority	Description	Points to check
E9	Medium	Internal hardware error	Contact OMRON HEALTHCARE.

NIBP

Error code	Priority	Description	Points to check
E1	Low	The cuff tube is not connected	Firmly connect the cuff tube.
		Air is leaking from the cuff.	Replace with an OMRON GS CUFF that does not leak.
E2	Low	Did not inflate properly because the arm or body moved during measurement.	Have the patient not move the arm or body, and repeat measurement.
		Moved body or arm during measurement, or talked.	Have the patient not talk or move, and repeat measurement.
		The cuff is not applied correctly.	Correctly apply the cuff.
		The sleeve is rolled up and is compressing the arm.	Remove the garment and re-wrap the cuff.
		Measurement time has exceeded specified time. Specified time: 165 seconds	The measurement time exceeds the expected time, so the measurement was ended in order to avoid patient discomfort. There is a possibility that measurement is being repeated over and over due to air leaking from the cuff.

Other problems

Error code	Priority	Cause	Solution
E3	Low	Inflated the cuff to 300 mmHg or more during inflation in "Auscultation Mode".	When inflating in "Auscultation Mode", release the button when the pressure reaches the desired value.
		Over-inflation occurs	If this occurs during measurement, repeat measurement. If this occurs when not performing measurement, contact OMRON HEALTHCARE.
E40	Medium	The battery is depleted.	Recharge the battery, or replace with a new battery. (page 14)
E41	Medium	Battery failed to charge.	Try charging again. If continues to fail, replace with a new battery. (page 14)
E42	Medium	Battery voltage error	Replace the battery with a new battery. If the error continues, contact OMRON HEALTHCARE.

Disposal

Description

As there is a risk of environmental pollution, follow your applicable national and local legal regulations regarding disposal or recycling of this equipment and batteries.

The main constituents of each part are listed in the table below. As there is a risk of infection, do not recycle patient attachments such as cuffs, but dispose of them as instructed by your facility's procedures and applicable regulations.

Item	Parts	Material
Package	Box	Cardboard
	Cushion	Cardboard
	Bag	PE
Main unit and accessories	Enclosure	ABS, PC , SR
	Internal parts	General electronic components
Battery pack	Outer tube	PVC
	Cell batteries	Nickel-metal hydride
	Internal parts	General electronic components

Specifications

Factory Default Settings

Factory default settings and backup are as shown below.

Backup



○: Setting is retained even if the power is interrupted.

△: Reverts to factory default setting if the power is turned off.

Setting Pressure Value	Settings	Factory Setting	Backup
Initial Inflation Pressure Value	AUTO, 220, 250, 280	AUTO	△
Auscultation Mode	ON, OFF	OFF	△
Auto Power Off	5 min, 10 min	5 min	○

Technical Specifications: HBP-1300

Main unit

Measurement Parameter	NIBP, PR
Dimension	Main unit: 123 x 201 x 99 (mm) 4.84 x 7.91 x 3.90 (inch) (W x H x D) AC adapter: 46 x 66 x 37 (mm) 1.81 x 2.60 x 1.46 (inch) (W x H x D) Battery: 54 x 43.5 x 15.4 (mm) 2.13 x 1.71 x 0.61 (inch) (W x H x D)
Weight	Main unit: Approx. 0.52 kg (not including accessories and options) AC adapter: Approx. 0.2 kg Battery: Approx. 0.1 kg
Display	7 segment LCD
Protection Class	Class II (AC Adapter)  Internal powered equipment (when operating with battery only)
Degree of Protection	Type BF 
MDD Classification	Class II a

Power supply

AC adapter	Input voltage range: AC 100 V to 240 V Frequency: 50/60 Hz Output voltage range: DC 6 V ±5% Rated output current: 1.6 A
Rechargeable battery	Type: 3.6 V, 1900 mAh Number of operation cycles when fully charged: 300 Measurement conditions <ul style="list-style-type: none"> • New battery fully charged • Ambient temperature of 23°C (73.4°F) • Using M-size cuff • SYS 120 / DIA 80 / PR 60 (Inflation setting: AUTO) • One 5-minute cycle consisting of “cuff measurement time + wait time”

Environmental Conditions

Operational temperature and humidity	Temperature range: 10 to 40°C (50 to 104°F) Humidity range: 30 to 85%RH (not condensed) Atmospheric pressure: 700 to 1060hPa
Storage and transportation	Temperature range: -20 to 60°C (-4 to 140°F) Humidity range: 10 to 95%RH (not condensed) Atmospheric pressure: 500 to 1060hPa

Non-Invasive Blood Pressure (NIBP)

Measurement technology	Oscillometric
Measurement method	Dynamic Linear Deflation method
Pressure display range	0 to 300 mmHg
Pressure display accuracy	Within ± 3 mmHg
NIBP measurement range	SYS 60 to 250 mmHg DIA 40 to 200 mmHg Pulse rate 40 to 200 /min
NIBP accuracy*	Maximum mean error within ± 5 mmHg Maximum standard deviation within 8mmHg
Pulse rate accuracy	Within ± 5 % of reading
Reference standard:	EN1060-1:1995+A2:2009 EN1060-3:1997+A2:2009 ISO81060-1:2007

* Comparison with auscultation method performed by a trained professional.
DIA determined by the auscultation method is "K5".

Note: Specifications may be changed without prior notice.

CE 0197

This blood pressure monitor fulfils the requirements of the EC directive 93/42/EEC (Medical Device Directive). It also conforms to the European standard EN 1060, Non-invasive Sphygmomanometers Part 1: General Requirements and Part 3: Additional Requirements for Electromechanical Blood Pressure Measuring Systems.

EN

Important information regarding Electro Magnetic Compatibility (EMC)

With the increased number of electronic devices such as PC's and mobile (cellular) telephones, medical devices in use may be susceptible to electromagnetic interference from other devices. Electromagnetic interference may result in incorrect operation of the medical device and create a potentially unsafe situation.

Medical devices should also not interfere with other devices.

In order to regulate the requirements for EMC (Electro Magnetic Compatibility) with the aim to prevent unsafe product situations, the EN60601-1-2:2007 standard has been implemented. This standard defines the levels of immunity to electromagnetic interferences as well as maximum levels of electromagnetic emissions for medical devices.

This medical device manufactured by OMRON HEALTHCARE conforms to this EN60601-1-2:2007 standard for both immunity and emissions.

Nevertheless, special precautions need to be observed:

- Do not use mobile (cellular) telephones and other devices, which generate strong electrical or electromagnetic fields, near the medical device. This may result in incorrect operation of the unit and create a potentially unsafe situation. Recommendation is to keep a minimum distance of 7 m. Verify correct operation of the device in case the distance is shorter.

Further documentation in accordance with EN60601-1-2:2007 is available within this manual, refer to section "Manufacturer's Declaration".

Correct Disposal of This Product (Waste Electrical & Electronic Equipment)

This marking shown on the product or its literature, indicates that it should not be disposed with other household wastes at the end of its working life. To prevent possible harm to the environment or human health from uncontrolled waste disposal, please separate this product from other types of wastes and recycle it responsibly to promote the sustainable reuse of material resources.



Household users should contact either the retailer where they purchased this product, or their local government office, for details of where and how they can take this item for environmentally safe recycling.

Business users should contact their supplier and check the terms and conditions of the purchase contract. This product should not be mixed with other commercial wastes for disposal.

This product does not contain any hazardous substances.

Disposal of used batteries should be carried out in accordance with the national regulations for the disposal of batteries.

Manufacturer's Declaration

The HBP-1300 is intended for use in the electromagnetic environment specified below.
The customer or the user of the HBP-1300 should assure that it is used in such an environment.

Electromagnetic Emissions:
(IEC60601-1-2)

Emission Test	Compliance	Electromagnetic Environment
RF emission CISPR 11	Group 1	The HBP-1300 uses RF energy only for internal functions. Therefore, this RF emission is extremely weak and there is little chance of it creating any kind of interference whatsoever with nearby electronic equipment.
RF emissions CISPR 11	Class B	The HBP-1300 is suitable for use in all establishments, including domestic establishments and those directly connected to the public low voltage power supply network that supplies buildings used for domestic purposes.
Harmonic emissions IEC 61000-3-2	Class A	
Voltage fluctuations/flicker IEC 61000-3-3	Complies	

Electromagnetic Immunity:
(IEC60601-1-2)

Immunity test	IEC60601-1-2 test level	Compliance level	Electromagnetic environment - guidance
Electrostatic discharge (ESD) IEC 61000-4-2	±6 kV contact ±8 kV air	±6 kV contact ±8 kV air	Floors should be wood, concrete or ceramic tile. If floors are covered with synthetic material, the relative humidity should be at least 30 %.
Electric fast transient/ burst IEC 61000-4-4	±2 kV for power supply lines ±1 kV for input/ output lines	±2 kV for power supply lines ±1 kV for input/ output lines	Mains power quality should be that of a typical commercial or hospital environment.
Surge IEC 61000-4-5	±1 kV differential mode ±2 kV common mode	±1 kV differential mode ±2 kV common mode	Mains power quality should be that of a typical commercial or hospital environment.
Voltage dips, short interruptions and voltage variations on power supply input lines IEC 61000-4-11	<5 % U_T for 0.5 cycle	<5 % U_T for 0.5 cycle	Mains power quality should be that of a typical commercial or hospital environment. If the user of the HBP-1300 requires continued operation during power mains interruptions, it is recommended that the HBP-1300 be powered from an uninterruptible power supply or a battery.
	40 % U_T for 5 cycles	40 % U_T for 5 cycles	
	70 % U_T for 25 cycles	70 % U_T for 25 cycles	
	<5 % U_T for 5 sec.	<5 % U_T for 5 sec.	
Power frequency (50/60 Hz) magnetic field IEC 61000-4-8	3 A/m	3 A/m	Power frequency magnetic fields should be at levels characteristic of a typical location in a typical commercial or hospital environment.
Note: U_T is the a.c. mains voltage prior to application of the test level.			

EN

Immunity test	IEC60601-1-2 test level	Compliance level	Electromagnetic environment - guidance
<p>Conducted RF IEC 61000-4-6</p> <p>Radiated RF IEC 61000-4-3</p>	<p>3 Vrms 150 kHz to 80 MHz 80% AM (2Hz)</p> <p>3 V/m 80 MHz to 2.5 GHz 80% AM (2Hz)</p>	<p>3 Vrms</p> <p>3 V/m</p>	<p>Portable and mobile RF communications equipment should be used no closer to any part of the HBP-1300, including cables, than the recommended separation distance calculated from the equation applicable to the frequency of the transmitter.</p> <p>Recommend separation distance</p> <p>$d = 1.2 \sqrt{P}$ 150 kHz to 80 MHz $d = 1.2 \sqrt{P}$ 80 MHz to 800 MHz $d = 2.3 \sqrt{P}$ 800 MHz to 2.5 GHz</p> <p>where P is the maximum output power rating of the transmitter in watts (W) according to the transmitter manufacturer and d is the recommended separation distance in meters (m).</p> <p>Field strengths from fixed RF transmitters as determined by an electromagnetic site survey^a, should be less than the compliance level in each frequency range^b.</p> <p>Interference may occur in the vicinity of equipment marked with the following symbol:</p> 
<p>Note1: At 80 MHz and 800 MHz, the higher frequency range applies. Note2: These guidelines may not apply in all situations. Electromagnetic propagation is affected by absorption and reflection from structures, objects, and people.</p>			
<p>^a Field strengths from fixed transmitters, such as base stations for radio (cellular/cordless) telephones and land mobile radios, amateur radio, AM and FM radio broadcast and TV broadcast cannot be predicted theoretically with accuracy. To assess the electromagnetic environment due to fixed RF transmitters, an electromagnetic site survey should be considered. If the measured field strength in the location in which the HBP-1300 is used exceeds the applicable RF compliance level above, the HBP-1300 should be observed to verify normal operation. If abnormal performance is observed, additional measures may be necessary, such as reorienting or relocating the HBP-1300.</p> <p>^b Over the frequency range 150 kHz to 80 MHz, field strengths should be less than 3 V/m.</p>			

Recommended Separation Distances:

Recommended separation distance between portable and mobile RF communications equipment and the HBP-1300

The HBP-1300 is intended for use in an electromagnetic environment in which radiated RF disturbances are controlled. The customer or the user of the HBP-1300 can help prevent electromagnetic interference by maintaining a minimum distance between portable and mobile RF communications equipment (transmitters) and the HBP-1300 as recommended below, according to the maximum output power of the communications equipment.

Rated maximum output power of transmitter (W)	Separation distance according to frequency of transmitter m		
	150 kHz to 80 MHz $d = 1.2 \sqrt{P}$	80 MHz to 800 MHz $d = 1.2 \sqrt{P}$	800 MHz to 2.5 GHz $d = 2.3 \sqrt{P}$
0.01	0.12	0.12	0.23
0.1	0.38	0.38	0.73
1	1.2	1.2	2.3
10	3.8	3.8	7.3
100	12	12	23

For transmitters rated at a maximum output power not listed above, the recommended separation distance d in metres (m) can be determined using the equation applicable to the frequency of the transmitter, where P is the maximum output power rating of the transmitter in watts (W) according to the transmitter manufacturer.

Note1: At 80MHz and 800MHz, the separation distance for the higher frequency range applies

Note2: These guidelines may not apply in all situations. Electromagnetic propagation is affected by absorption and reflection from structures, objects and people.

Manufacturer 	OMRON HEALTHCARE Co., Ltd. 53, Kunotsubo, Terado-cho, Muko, Kyoto, 617-0002 JAPAN
EU-representative 	OMRON HEALTHCARE EUROPE B.V. Scorpius 33, 2132 LR Hoofddorp, THE NETHERLANDS www.omron-healthcare.com
Production facility	OMRON (DALIAN) CO., LTD. Dalian, CHINA
Subsidiary	OMRON HEALTHCARE UK LTD. Opal Drive, Fox Milne, Milton Keynes, MK15 0DG, U.K.
	OMRON MEDIZINTECHNIK HANDELSGESELLSCHAFT mbH Gottlieb-Daimler-Strasse 10, 68165 Mannheim, GERMANY www.omron-medizintechnik.de
	OMRON SANTÉ FRANCE SAS 14, rue de Lisbonne, 93561 Rosny-sous-Bois Cedex, FRANCE

Made in China